

FRONT VIEW

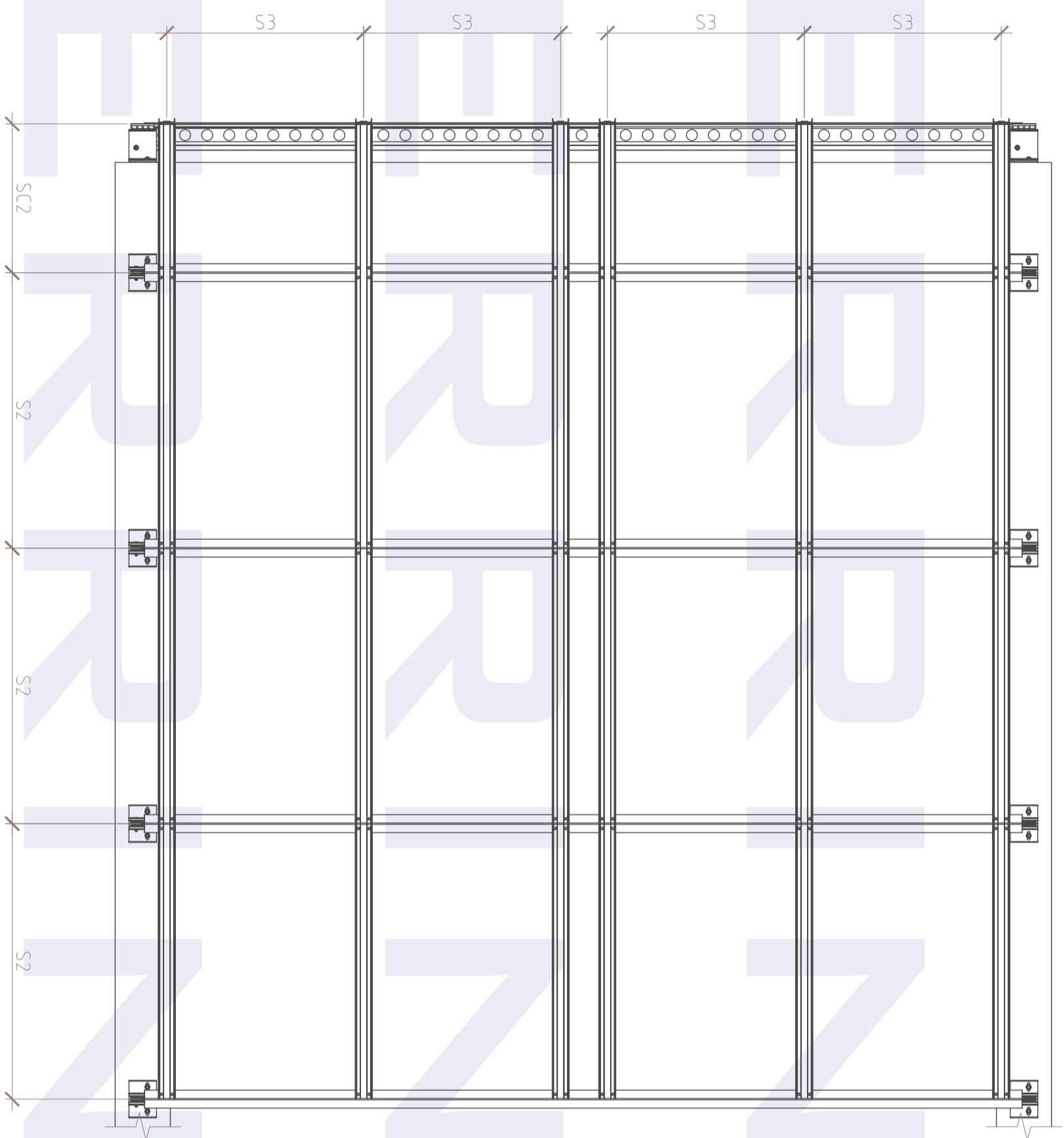

ELEVATION VIEW

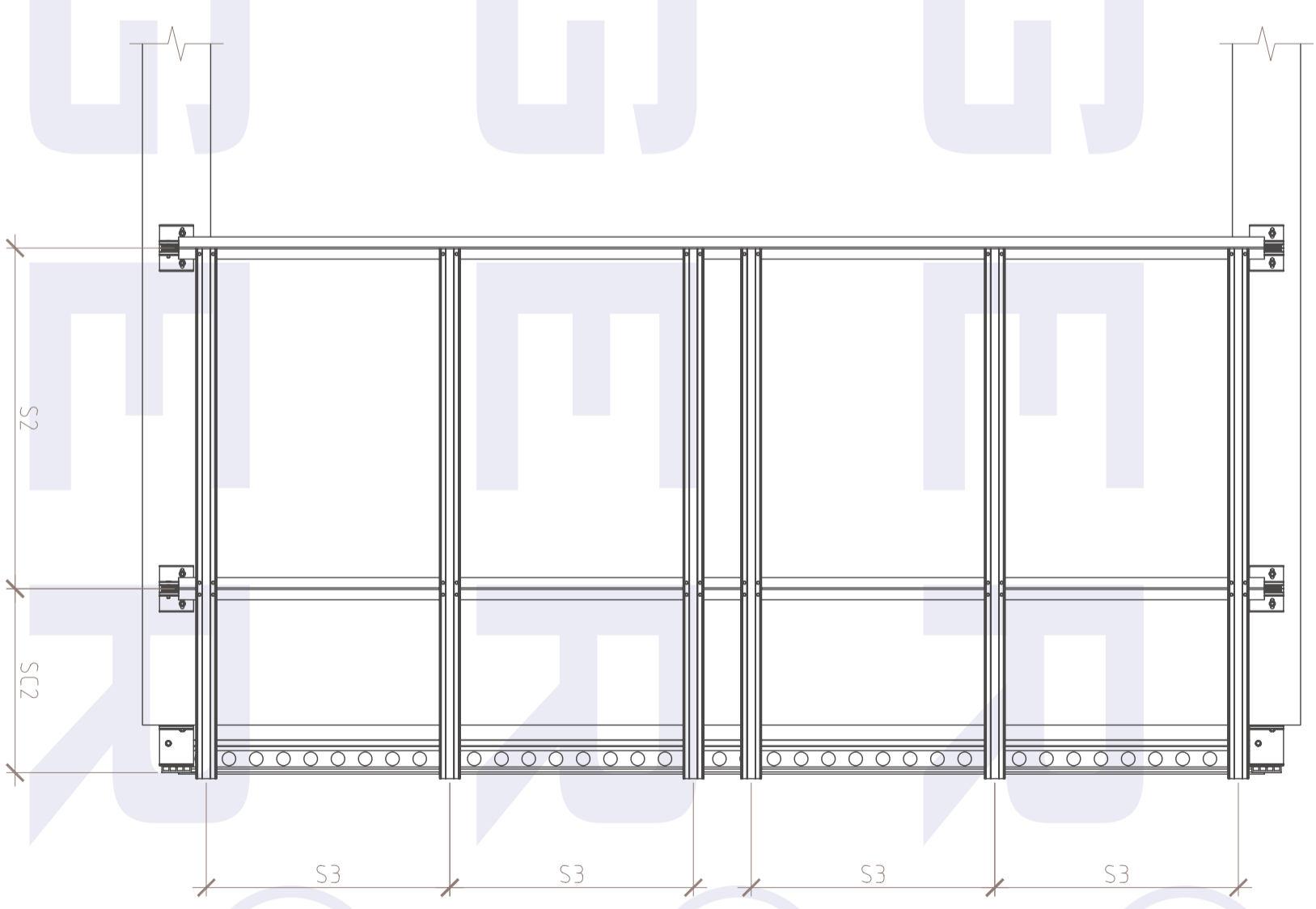

TOP VIEW

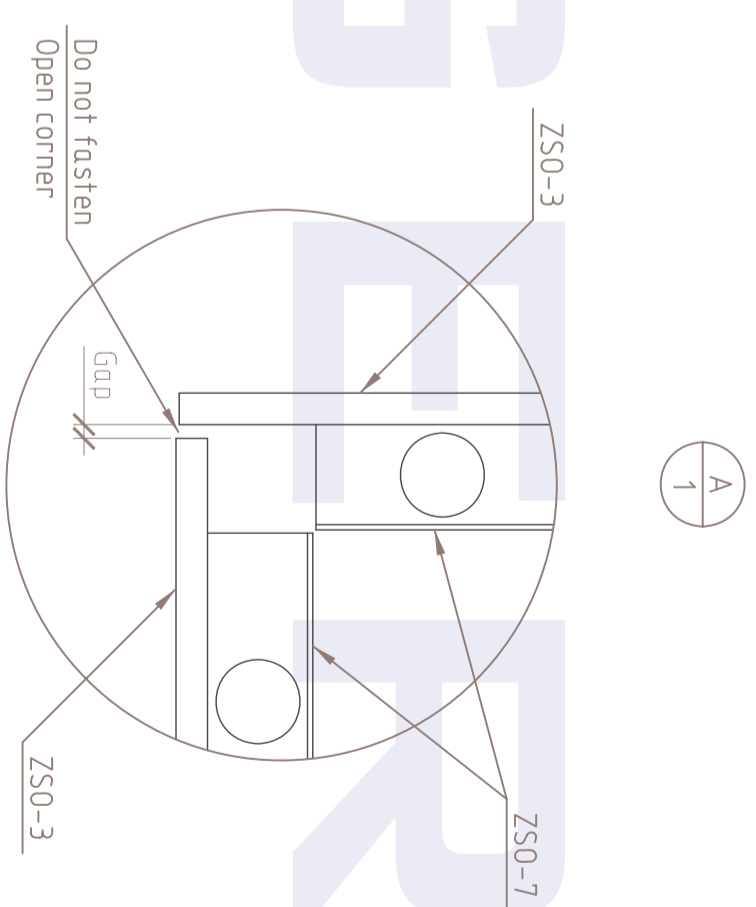
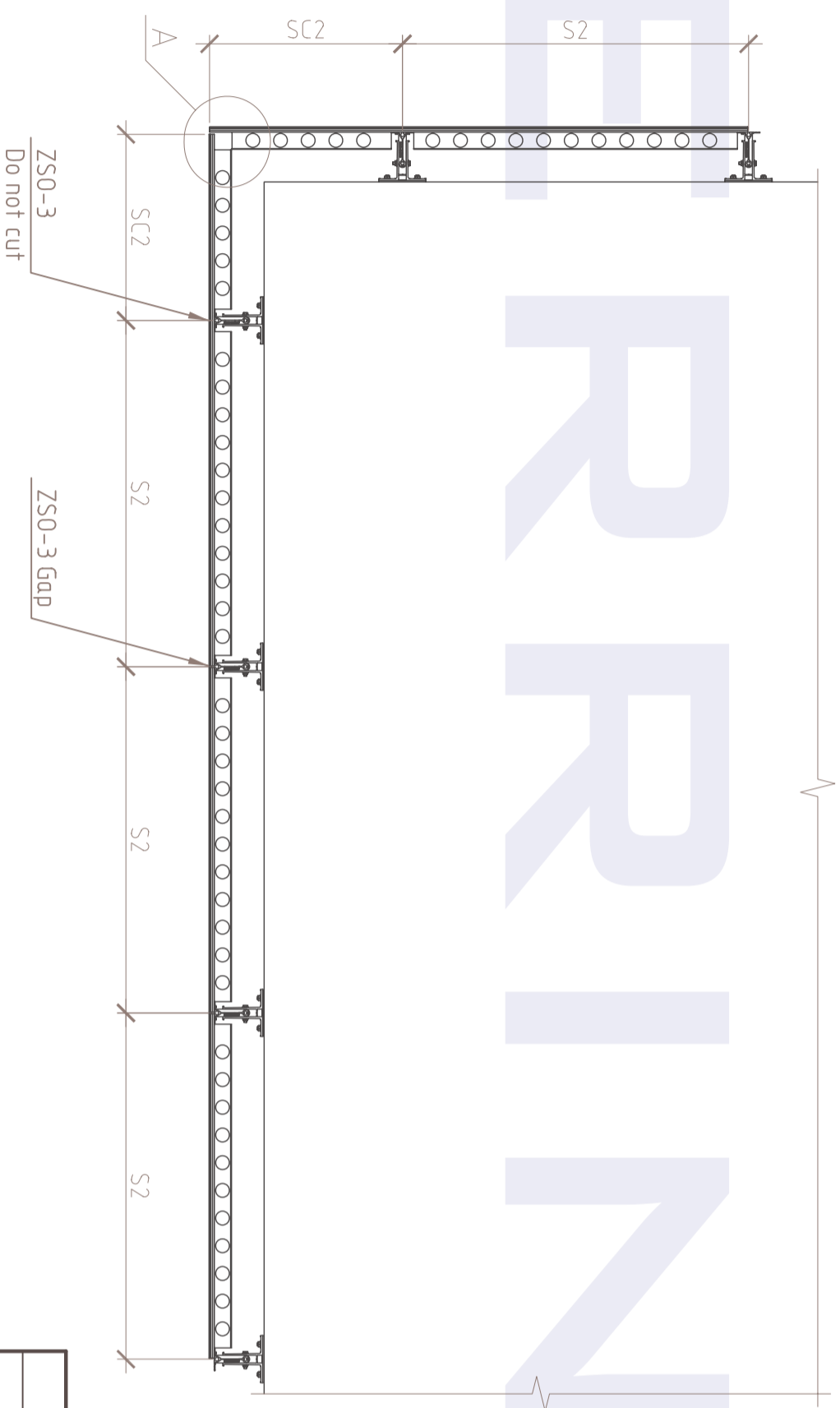

A
1

ZERRINGER

ZERRINGER.SnapOn.Epoxy Panel.Subframe

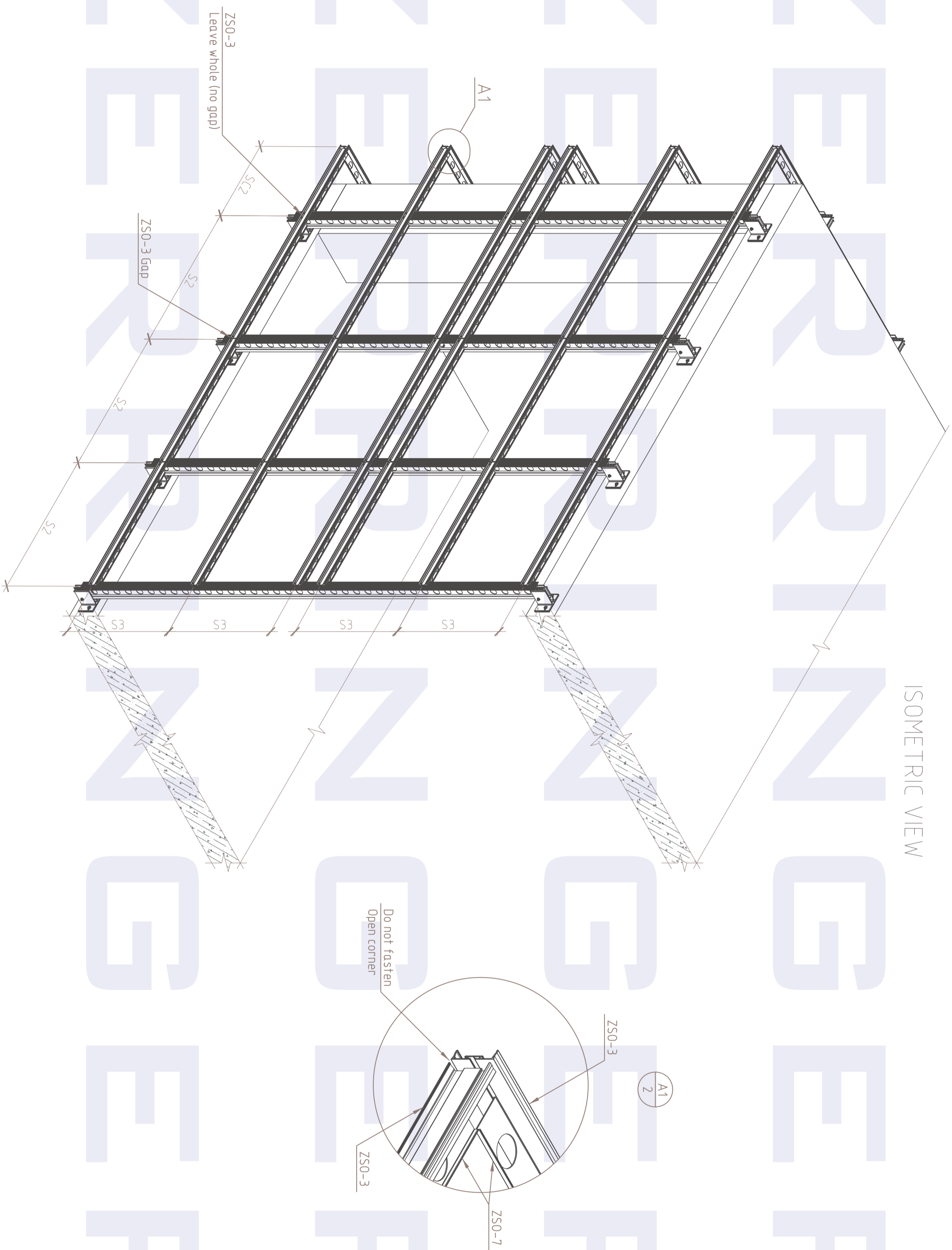

--	--	--	--	--	--	--	--	--	--



Adjusting point

Screw D8xL8
DIN ISO 7050

ZSO-8

Sliding point

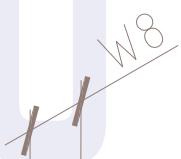

Gap 1
gaskets

ZSO-3

ZSO-7

Screw D8xL8
DIN ISO 7050



Gap 1

ZSO-3

ZSO-8

Adjusting point

Rivets D3



E1
4

Adjusting point

ZS0-8

Sliding point

ZS0-7

Panel

ZS0-2

ZS0-3

Adjuster bolt

Gap

ZS0-8

Adjusting point

Gap 1

Panel

ZS0-7

ZS0-3



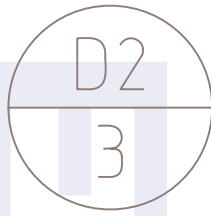

Fixed point

Screw D8xL8
DIN ISO 7050

ZS0-8

Sliding point

W8

Gap 1
gaskets

ZS0-3

ZS0-7

Screw D8xL8
DIN ISO 7050

W8

Gap 1

ZS0-8

Fixed point

ZS0-3

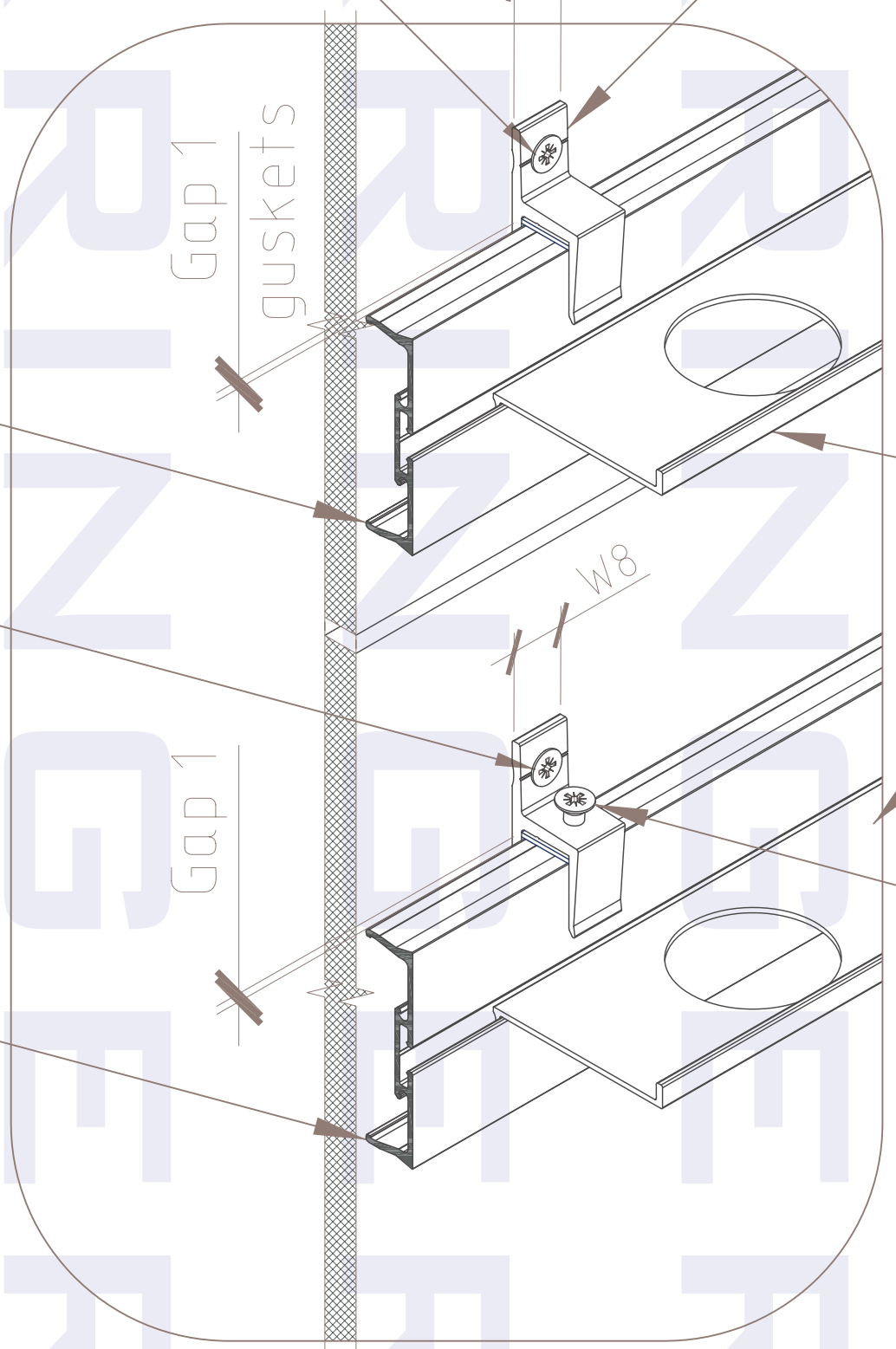

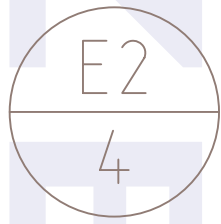

Fixed point

ZSO-8

Sliding point

ZSO-7

Panel

ZSO-2

ZSO-3

Fixing screw
Self-tapped
ZSO-8

Fixed point

Gap

Gap 1
gaskets

Panel

ZSO-7

ZSO-3



A

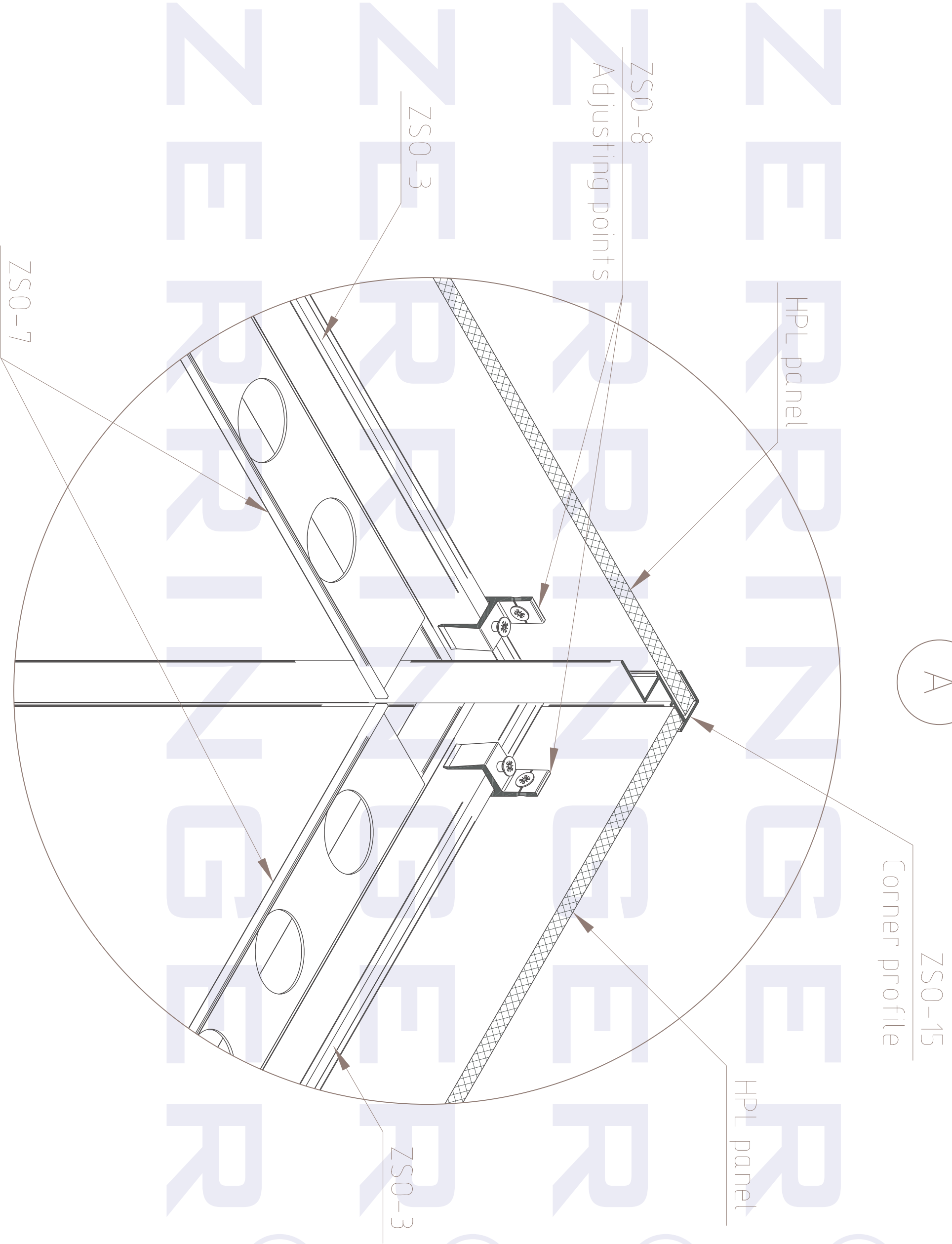

B

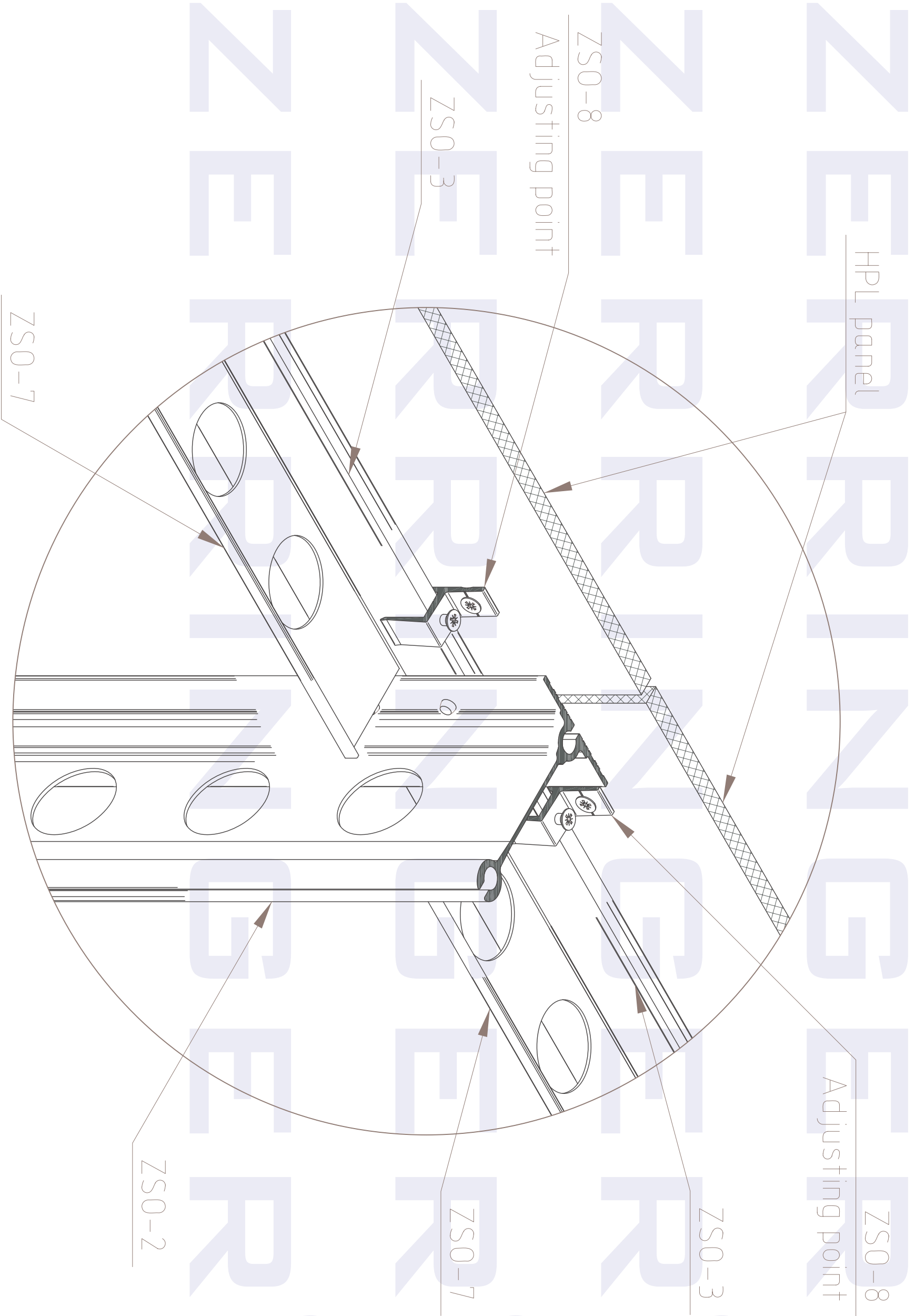

ELEVATION VIEW (blank wall)

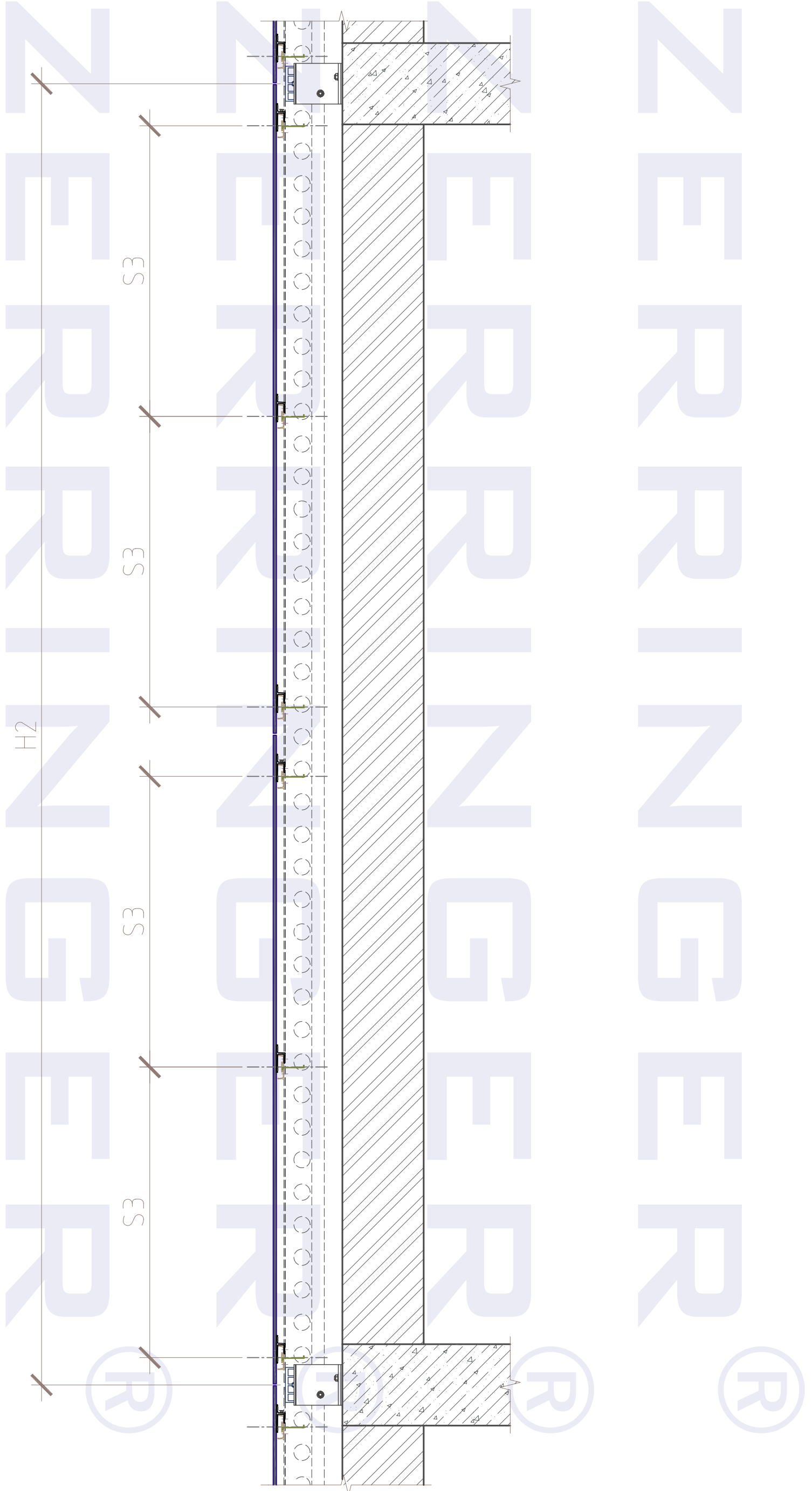

ELEVATION VIEW
(wall with window opening)

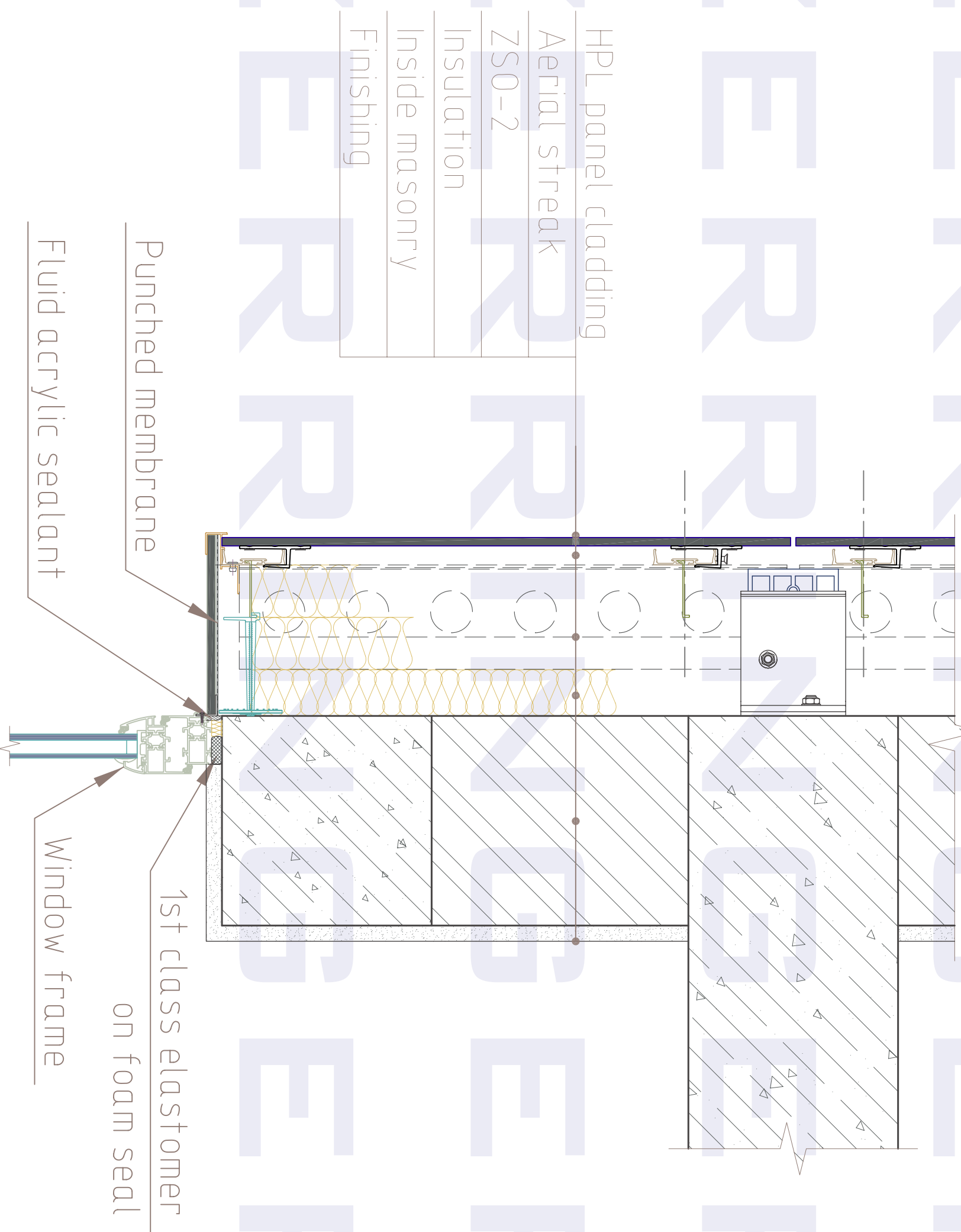

ELEVATION VIEW

(wall with window opening)

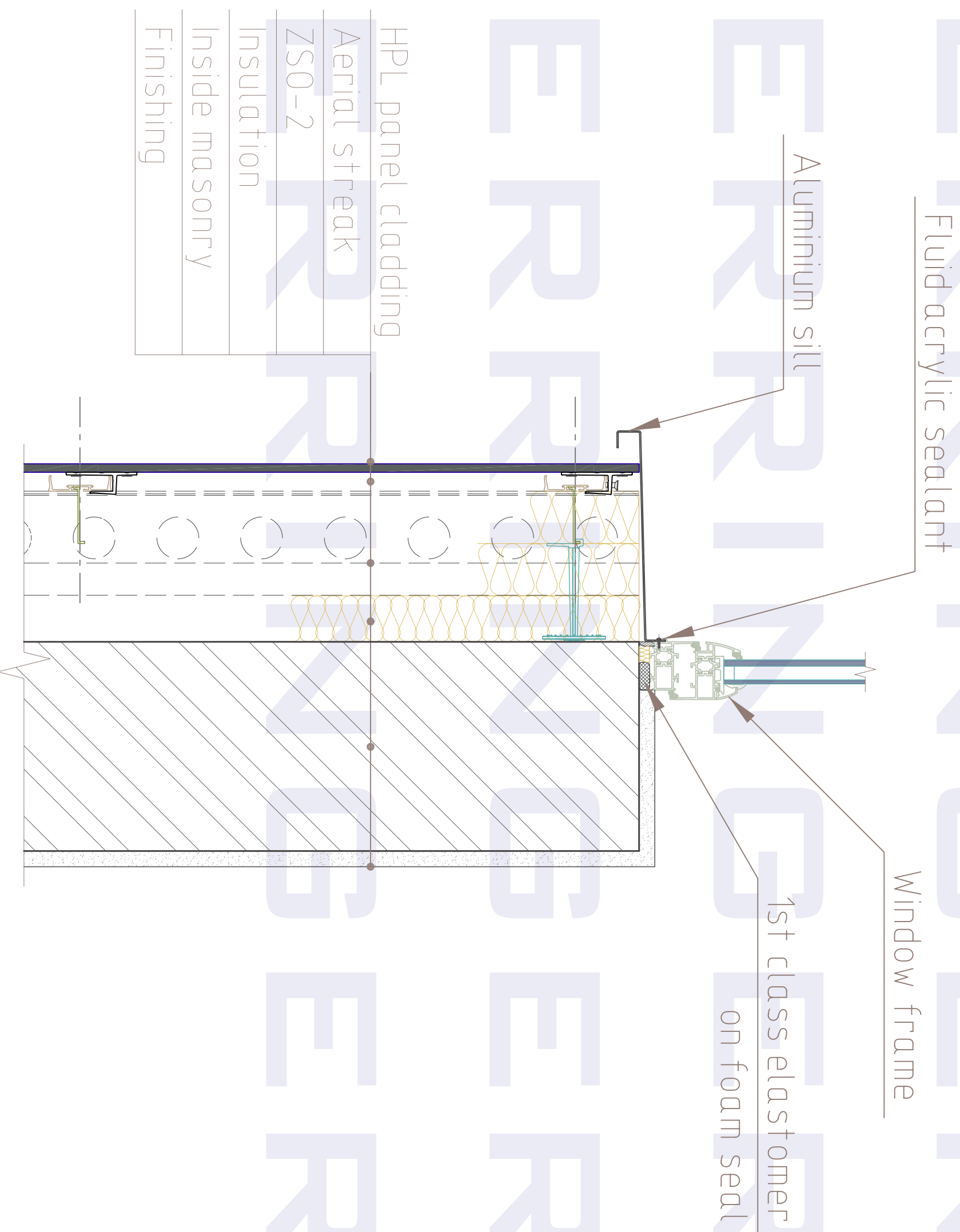

TOP VIEW
(window opening)

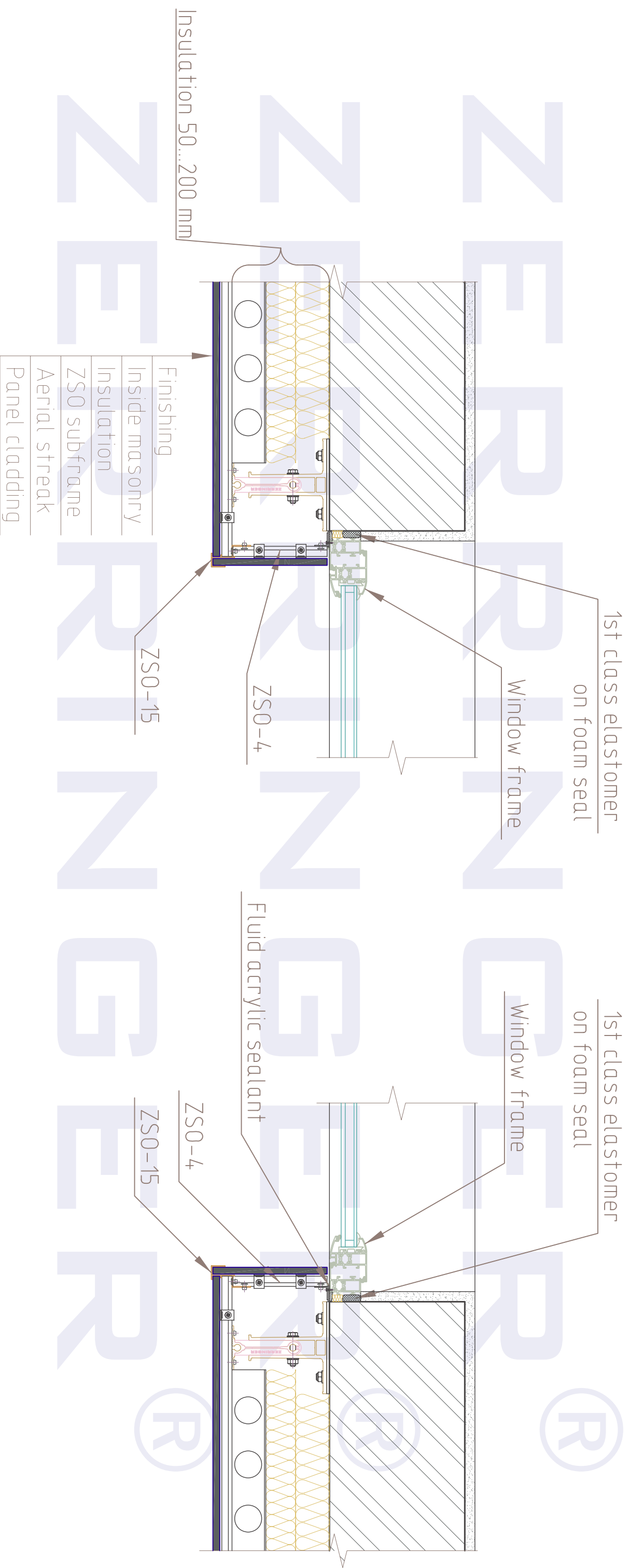

ELEVATION VIEW
(parapet)

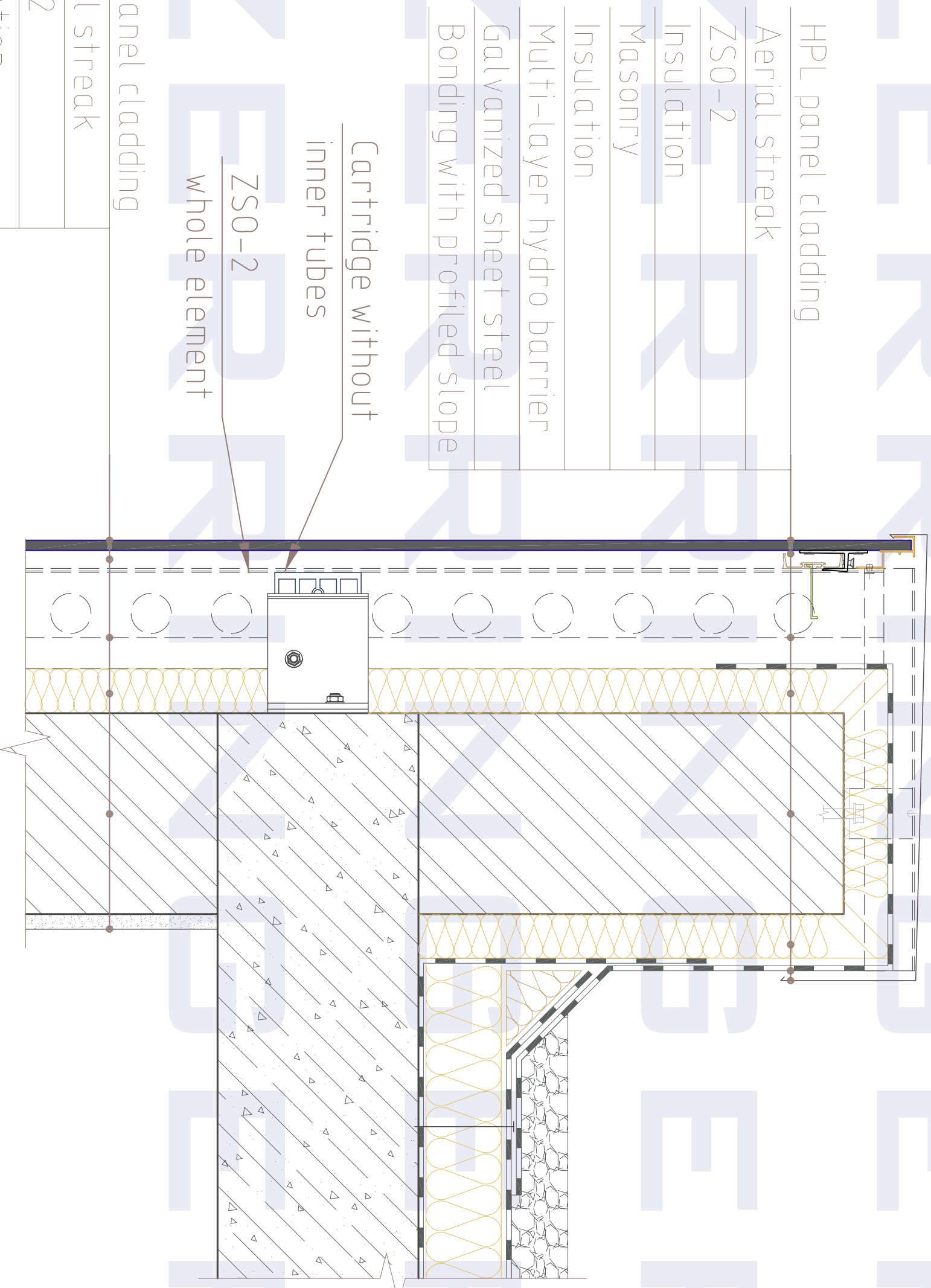

HPL panel cladding	HPL panel cladding
Aerial streak	Aerial streak
ZS0-2	ZS0-2
Insulation	Insulation
Masonry	Masonry
Insulation	Insulation
Multi-layer hydro barrier	Multi-layer hydro barrier
Galvanized sheet steel	Galvanized sheet steel
Bonding with profiled slope	Bonding with profiled slope
Cartridge without inner tubes	Cartridge without inner tubes
ZS0-2 whole element	ZS0-2 whole element
HPL panel cladding	HPL panel cladding
Aerial streak	Aerial streak
ZS0-2	ZS0-2
Insulation	Insulation
Inside masonry	Inside masonry
Finishing	Finishing

ELEVATION VIEW
(overlapping detail)

- HPL panel cladding
- Aerial streak
- ZS0-2
- Insulation
- Inside masonry
- Finishing

Expansion gap

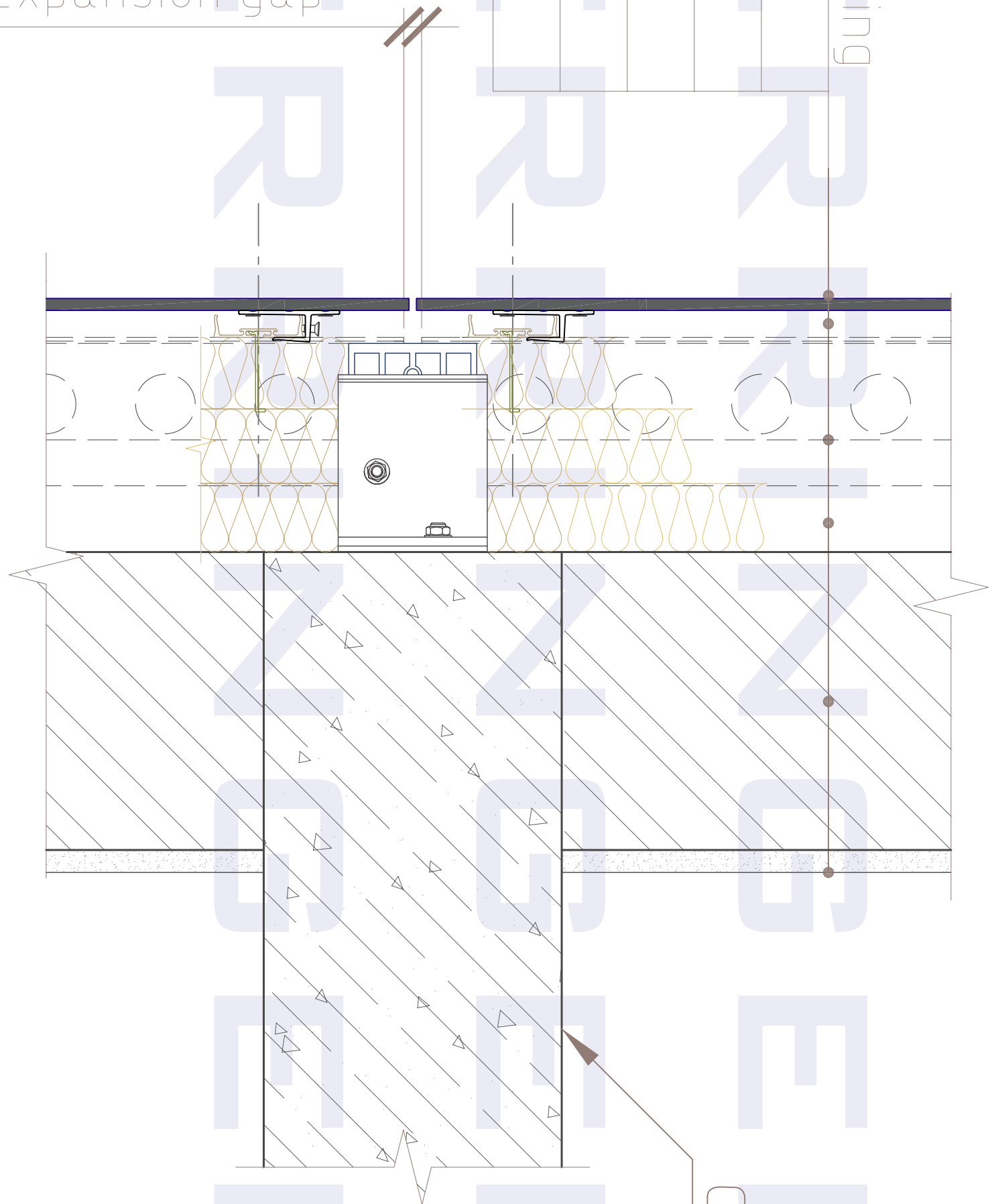

Concrete slab

ELEVATION VIEW (basement)

- HPL panel cladding
- Aerial streak
- ZSO-2
- Insulation
- Masonry
- Finishing

- HPL panel cladding
- Aerial streak
- ZSO-2
- Insulation
- Masonry
- Finishing

Perforation

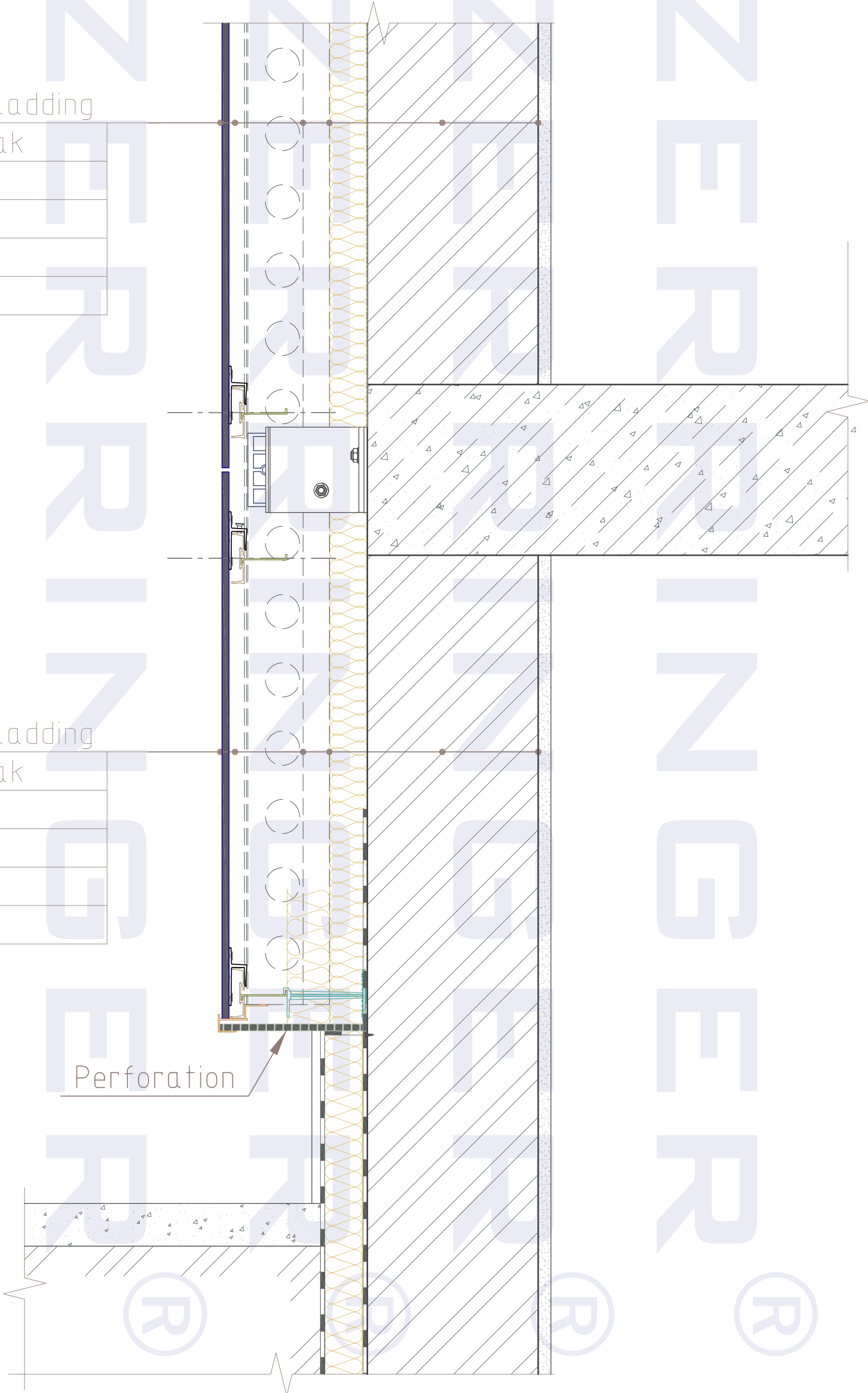

ELEVATION VIEW (balcony)

HPL panel cladding
Aerial streak
ZSO-2
Insulation
Masonry
Finishing

Aluminium bend sheet

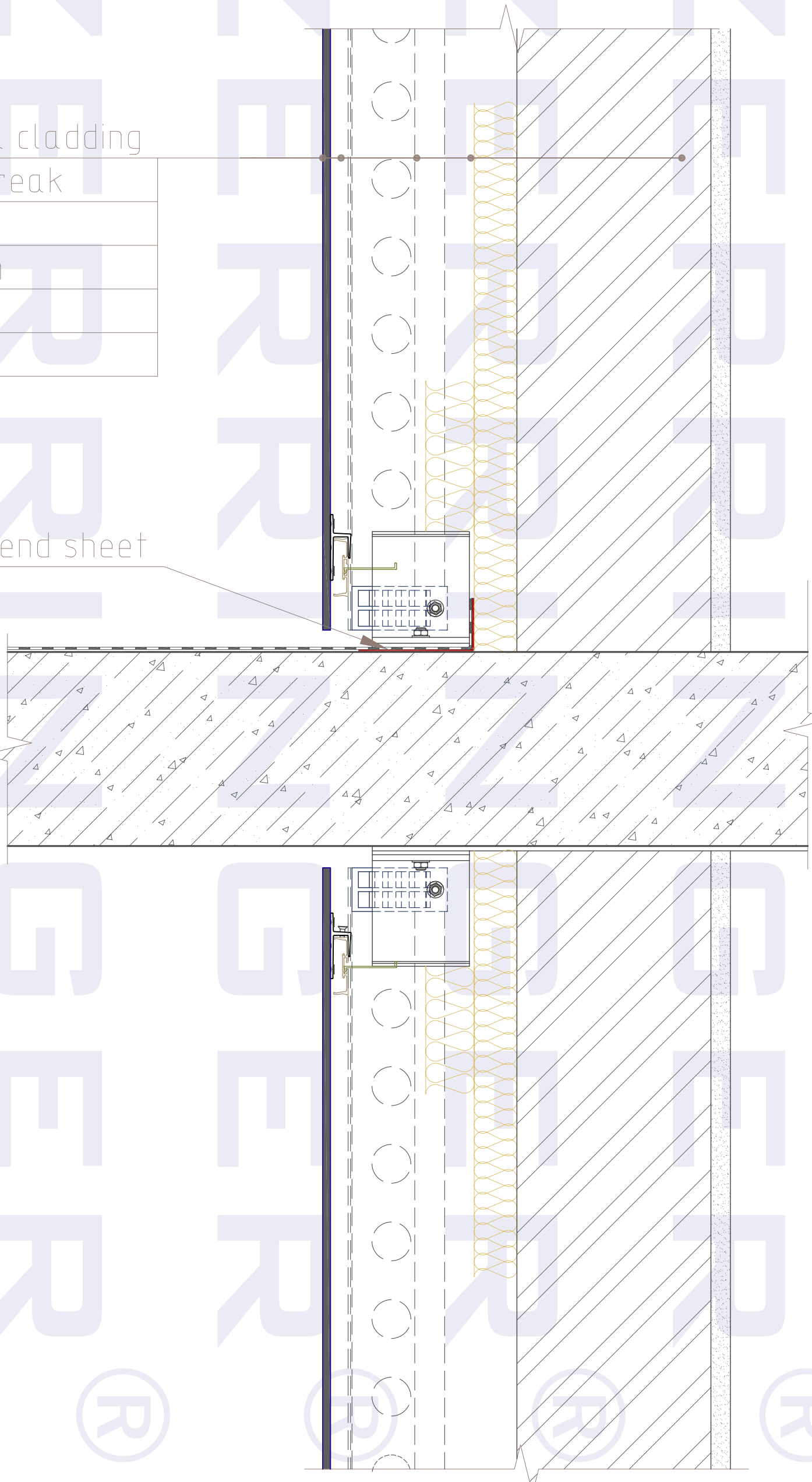
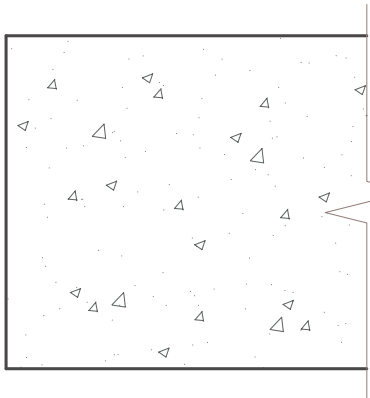

ELEVATION VIEW (balcony)

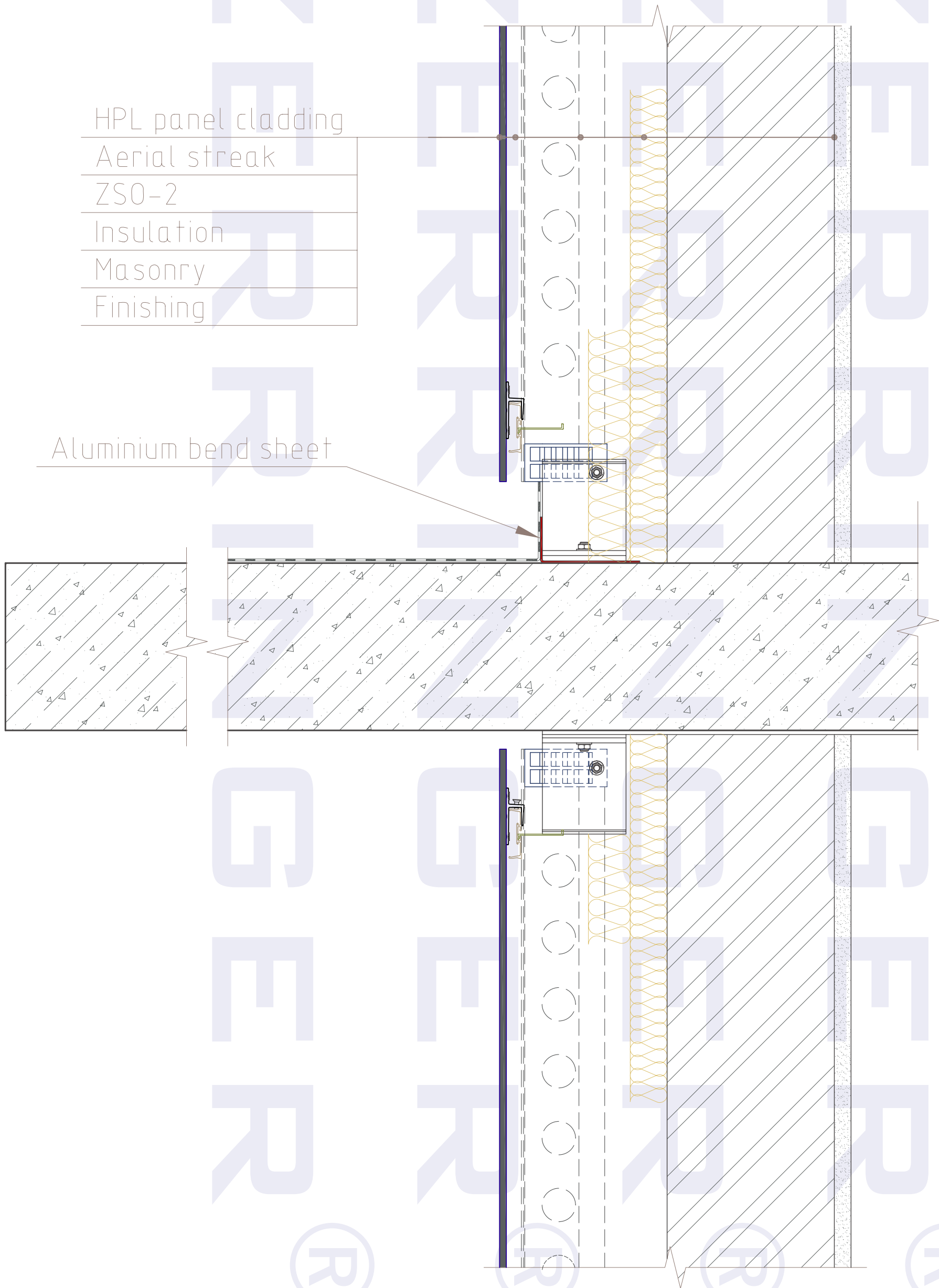

TOP VIEW - external corner
(open corner)

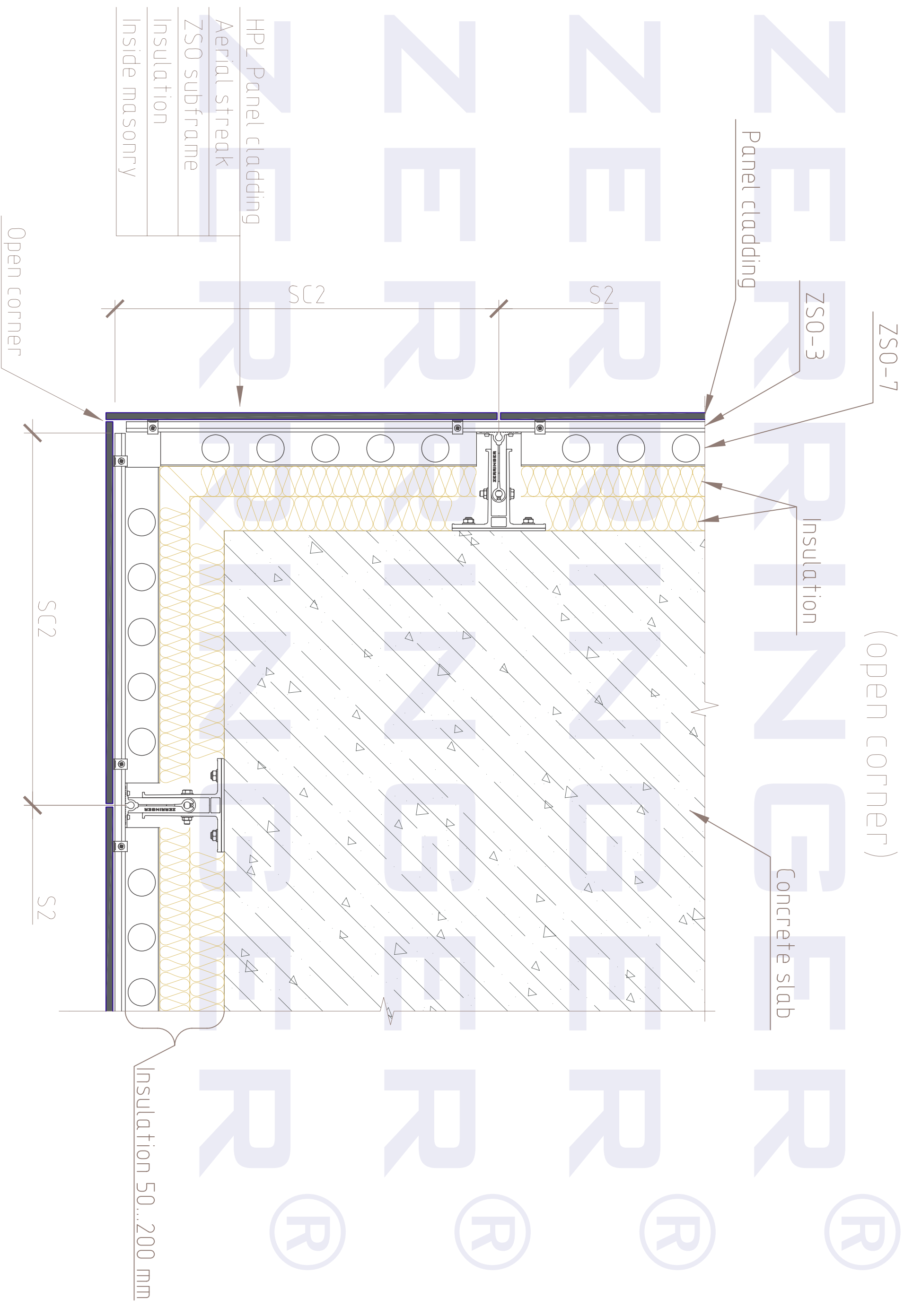

TOP VIEW - internal corner
(open corner)

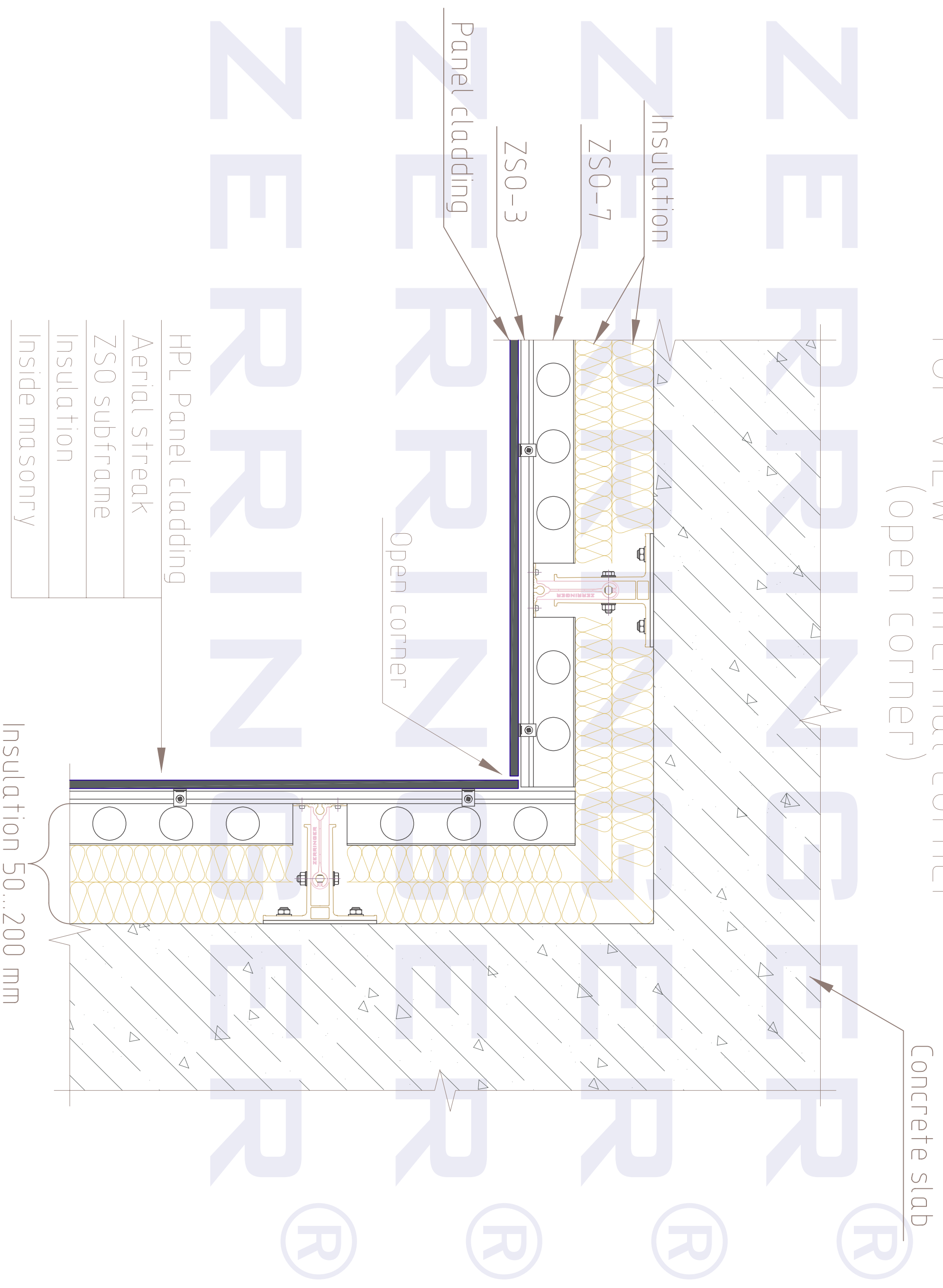

TOP VIEW - external corner
(corner profile)

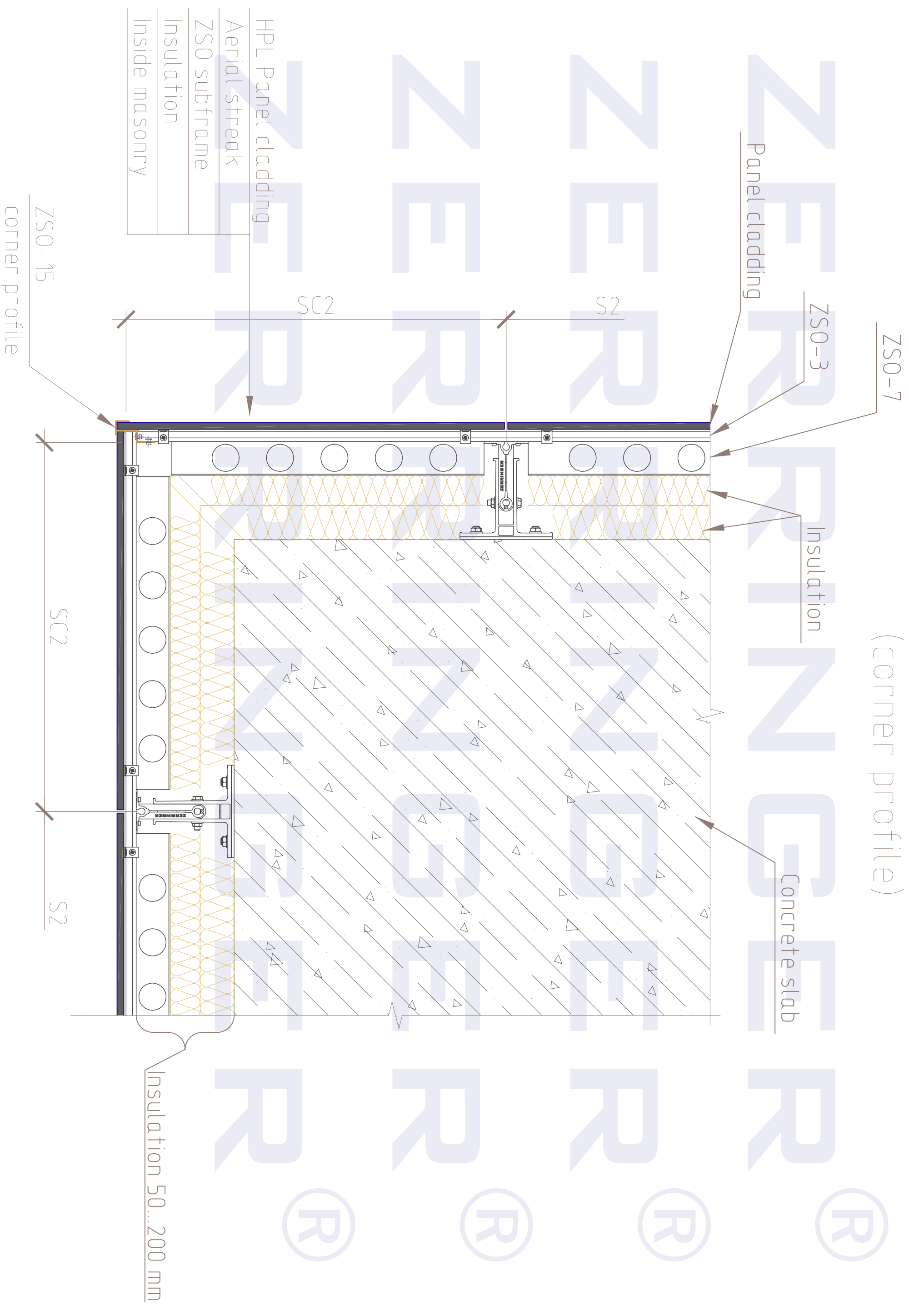

TOP VIEW - internal corner
(corner profile)

Concrete slab

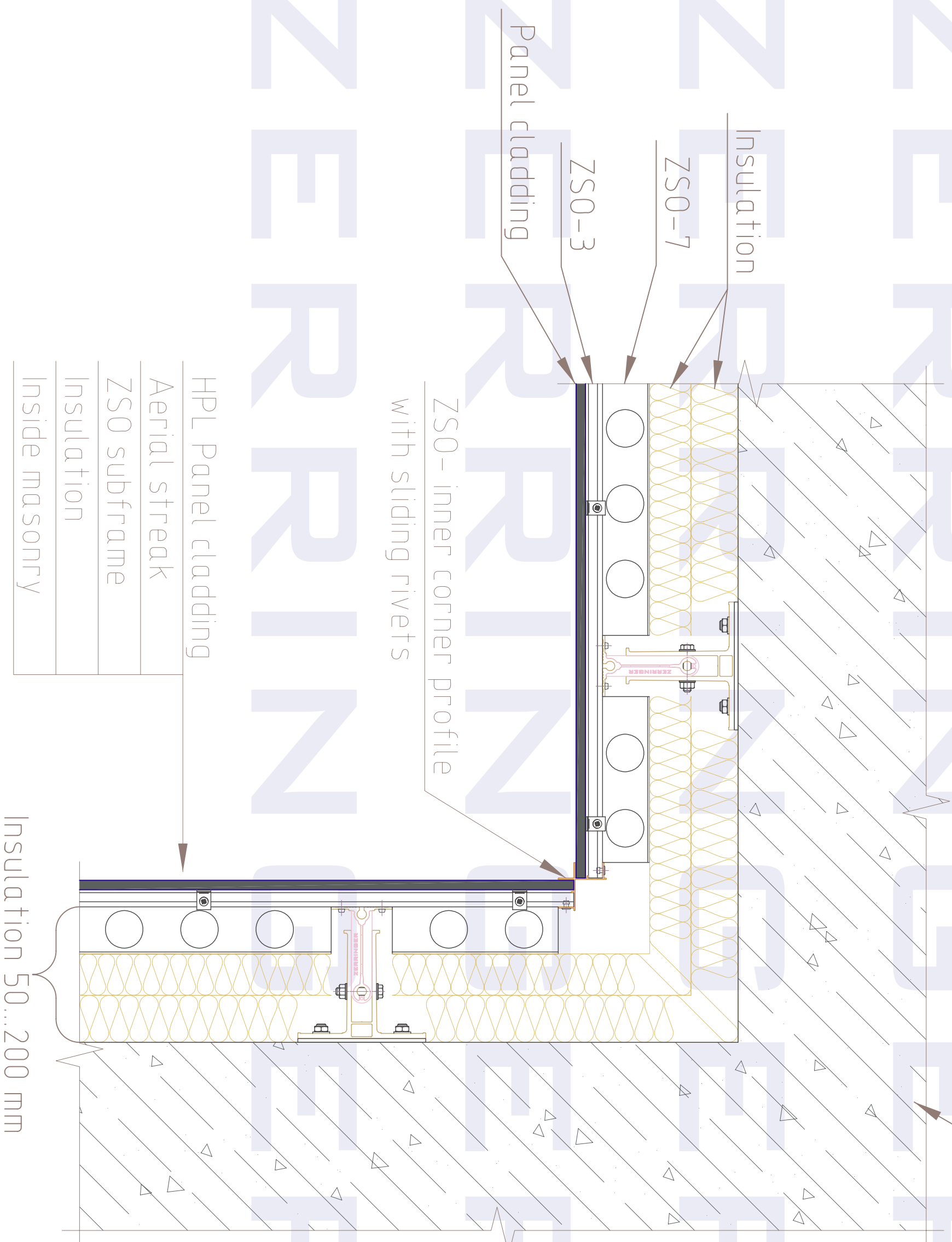

Insulation 50...200 mm

TOP VIEW - external corner
(trespa corner profile element)

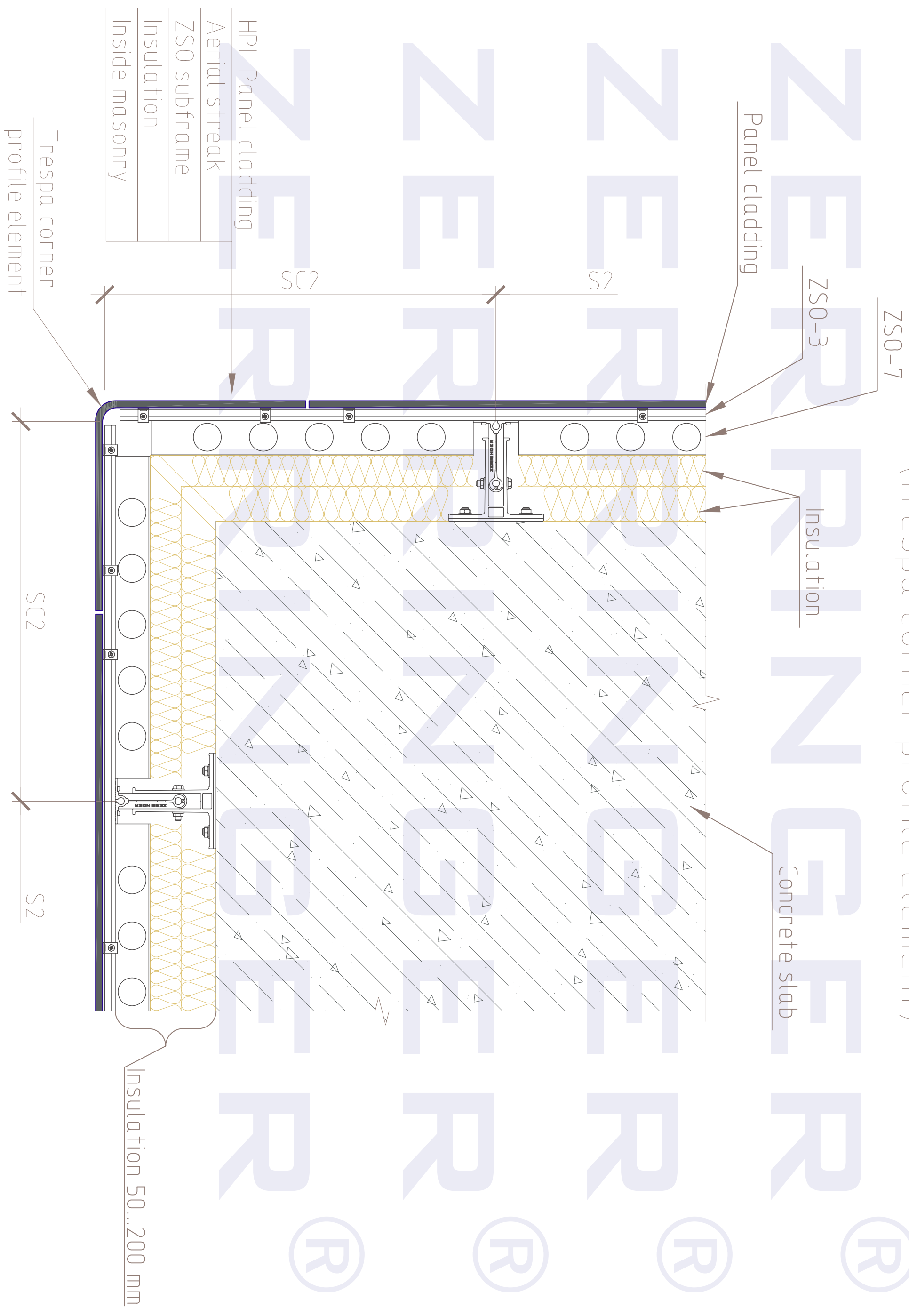

TOP VIEW - internal corner (trespa corner profile element)

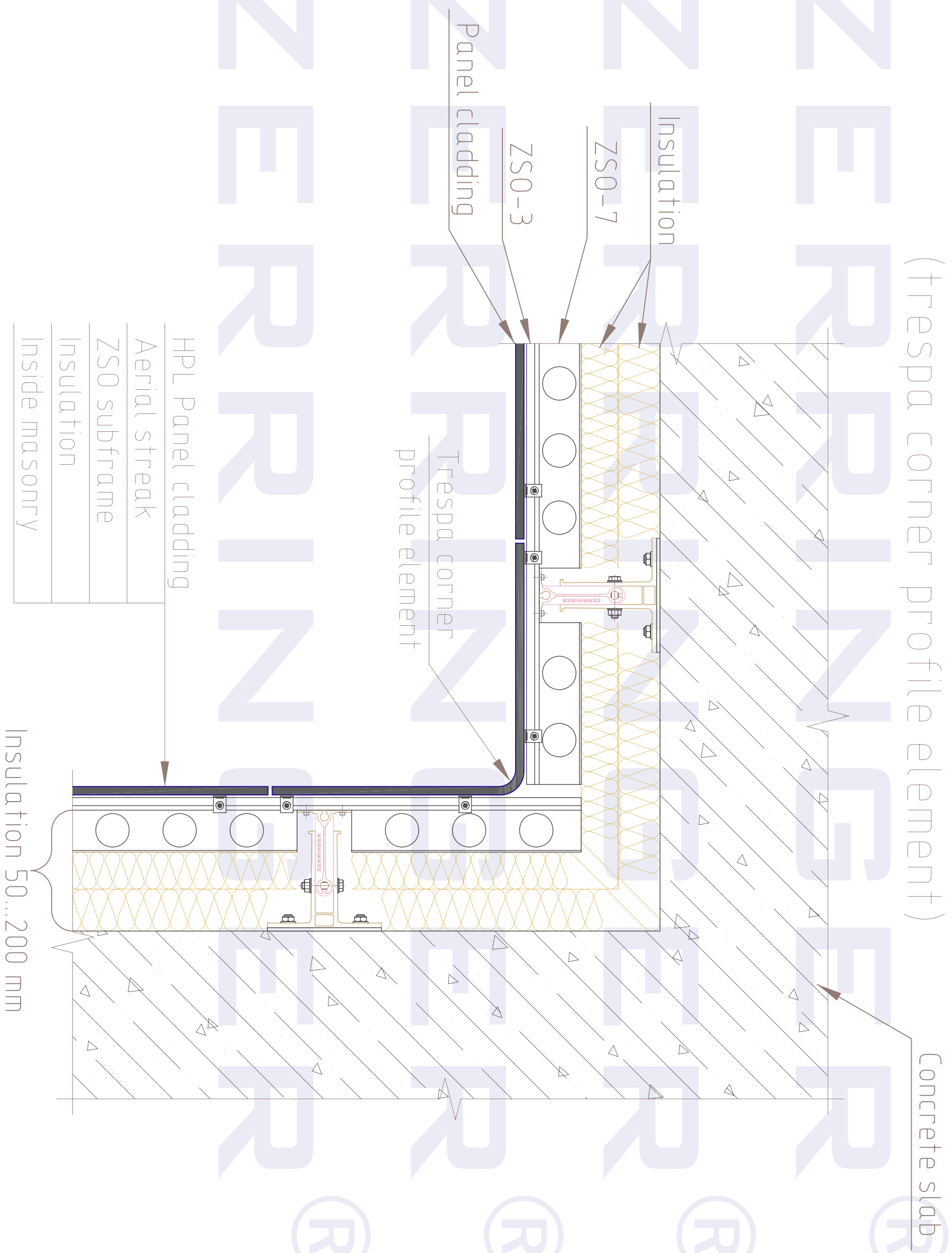

Concrete slab

Insulation

ZS0-7

ZS0-3

Panel cladding

Trespa corner
profile element

HPL Panel cladding

Aerial streak

ZS0 subframe

Insulation

Inside masonry

Insulation 50...200 mm